



RF Transceiver Module (Radio Modem)

Application

- ◆ Ultra low power wireless Transceiver
- ◆ 868/915 MHz ISM/SRD band systems
- ◆ Consumer Electronics
- ◆ Home and building automation
- ◆ Wireless sensor networks
- ◆ Industrial monitoring and control
- ◆ Low power Telemetry



Product Description

BIT868RM20 is a very low cost transceiver module designed for very low power wireless applications.

This module is intended for ISM (Industrial, Scientific and Medical) and SRD (Short Range Device) frequency band at 868/915 MHz., but can easily be programmed for operation at other frequencies in 800 – 928 MHz

It is designed to realize RF solutions easy to use providing a reliable data transfer among remote equipment. The module can operate with a UART (up to 115.2 kbps) connected host or as a stand- alone complete RF module.

It's fully programmable in a very small package: only 19 x 19 mm ready for SMT assembly.

Key Features

- ◆ Small size (19 x 19 mm package, 36 pins).
- ◆ Frequency bands:
- ◆ BIT868RM20 868,105 – 869,525 MHz
- ◆ High sensitivity : -121 dBm at 2 kbps, 1% PER
- ◆ Programmable output power up to + 20 dBm
- ◆ Low current consumption
- ◆ Operating Voltage : 1.8 to 3.6 V
- ◆ UART Data rate up to 115.2 kBaud
- ◆ Modulation: GFSK
- ◆ Programmable data rate
- ◆ Ideal for multi-channel operation.
- ◆ Excellent receiver selectivity and blocking performance.
- ◆ Suited for system compliant with EN 300 220 (Europe) and FCC CFR Part 15 (US).



1. Pin-Out

The radio modem is equipped with a certain number of pin available for the host application. Some are already used (see next sections); for the others it is possible to agree a product customization.

PIN N.	Description	Type	Default Configuration unused pin
P1	GND		
P2	RF ANTENNA	RF Analog I/O	
P3	GND		
P4	SI1030 P1.3	Digital or Analog I/O or XTAL 4	OUT/LO
P5	SI1030 P1.2	Digital or Analog I/O or XTAL 3	OUT/LO
P6	Module Ready to TX Uart (P0.7)	O	
P7	Host Ready to RX Uart (P0.6)	I	
P8	UART RX (P0.5)	IN	
P9	UART TX (P0.4)	OUT	
P10	SI1030 P0.3	I/O (optional SPI nSS)	OUT/LO
P11	SI1030 P0.2	I/O (optional SPI MOSI)	OUT/LO
P12	SI1030 P0.1	I/O (optional SPI MISO)	OUT/HI (2K2 pull-up)
P13	SI1030 P0.0	I/O (optional SPI SCK)	OUT/LO
P14	IN VDCDC	DO NOT CONNECT	
P15	OUT VDCDC	DO NOT CONNECT	
P16	GND		
P17	VBAT	CONNECT TO 3V3	
P18	GND		
P19	RESET/C2CK	ICSP clock	
P20	C2D	ICSP data	
P21	SI1030 P1.1	Digital or Analog I/O	OUT/LO
P22	SI1030 P1.0	I Digital or Analog I/O	OUT/LO
P23	SI1030 P2.5	Digital or Analog I/O	OUT/LO
P24	SI1030 P2.7	Digital or Analog I/O	OUT/LO
P25	SI1030 P2.6	Digital or Analog I/O	OUT/LO
P26	SI1030 P2.4	Digital or Analog I/O	OUT/LO
P27	GND		
P28	VCC	CONNECT TO 3V3	
P29	GND		
P30	SI1030 GPIO0	I/O	OUT/LO
P31	SI1030 GPIO1	I/O	OUT/LO
P32	SI1030 GPIO2	I/O	OUT/LO
P33	GND		
P34	SI1030 P1.6	Digital or Analog I/O (INT0 INPUT)	OUT/LO
P35	SI1030 P1.4	Digital or Analog I/O	OUT/LO
P36	SI1030 P1.7	Digital or Analog I/O (INT1 INPUT)	OUT/LO

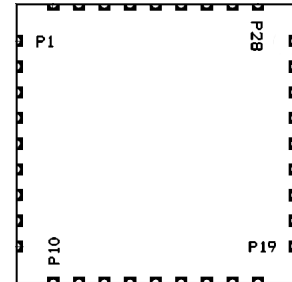

Table 1.1: Pin Description



2. Absolute Maximum Ratings

Parameter	Min.	Max.	Units	Remarks
Supply Voltage, VDD	-3	3.9	V	
Voltage on any pin	-0.3	VDD+0.3	V	
Input RF level		10	dBm	
Storage temperature range	-40	125	°C	

3. Operating Conditions and Specifications

Parameter	Min.	Typ.	Max.	Units	Remarks
RF Frequency Range	868.105	869.525	869.525	MHz	
Operation ambient temperature	-30		85	°C	
Supply voltage	1.8	-	3.6	V	valid ramp times (less than 3 ms)
Current Consumption		1 85 19	90	uA mA mA	Sleep mode TX mode @ max output power RX mode @ 2 kbps
Sensitivity		-121 -114 -108		dBm dBm dBm	@ 2 kbps @ 20 kbps @ 40 kbps

4. Product customization

The product is fully customizable upon request; it is possible to customize operating frequencies, data-rate, pin use, functions, etc. Please contact the Distributors closest to you for further information.

5. UART Interface

Any UART message has to be terminated by CRC a carriage return and a new line character (\rcr\rn – 0x0D 0x0A).

CRC is 8bit sum of all previous bytes with start value 0x80

At power on Module send a message “**BIT868RM20 Ready\rcr\rn**”

When the microcontroller on the module has nothing to do automatically goes into sleep mode while the front end radio depends on the configuration (PD and WOR command)

When host send an UART command module automatically wake-up

If module has to send an UART message, it set pin P6(P0.7) to logic HI (for wake-up host microcontroller) and wait for the host to set pin P7(P0.6) to logic HI. If this function does need pull-up pin P7(P0.6) to Vdd



Comm	Syntax	Description	val	Def Value
BR	BR=val\crc\r\n	Set the UART baud rate	0 to 6	6
PA	PA=val\crc\r\n	Set the output power	0 to 7	See 5.2
CH	CH=val\crc\r\n	Set the RF channel	0 to 4	See 5.3
RF	RF=val\crc\r\n	Set the RF configuration	0 to 2	See 5.4
NWA	NWA=val\crc\r\n	Set the module Network Address	0 to 255	211
MYA	MYA=val\crc\r\n	Set the module Address	0 to 255	255
WOR	WOR=val\crc\r\n	Set module Wake On Radio mode	0 or 20 to 64000	0
TX	TXval	Set the module TX mode	See 5.8	See 5.8
PD	PD=val\crc\r\n	Set the module power down mode	0 or 20 to 64000	0
CCA	CCA=val\crc\r\n	Enable CCA mode	0 or 20 to 230	0
STA	STA=?\crc\r\n	Return Module Status	Only '?'	
FWVER	FWVER=?\crc\r\n	Return FW version	Only '?'	
SAVE	SAVE=1\crc\r\n	Save all current settings in NVM	Only '1'	

If val is the character '?', BIT868RM20 return the current value of the command + CRC followed by a carriage return and a new line (\r\n – 0x0D 0x0A) .

val values are ASCII coded values.

If val is one of the allowable values, BIT868RM20 returns the string “OK\crc\r\n” if the command is correctly executed, “ERR\crc\r\n” otherwise.

Exception is the TX command. For this command '?' parameter is not allowed.

BIT868RM20 returns the string “OK\crc\r\n” if the command syntax is correct, “ERR\r\n” otherwise.



5.1. BR: UART Baud Rate

The UART baud rate can be set to 5 different values. The possible settings are shown in next table.

BR	UART Baud Rate (bps)
0	2400
1	4800
2	9600
3	19200
4	38400
5	57600
6 (default)	115200

5.2. PA: Output Power

PA	Output Power (dBm)	Current consumption typ. [mA]
0	-1	TBD
1	2	TBD
2	5	TBD
3	8	TBD
4	11	TBD
5	14	TBD
6	17	TBD
7	20	TBD

CAUTION: The module has been certified with MAX TX POWER 869 MHz RF settings = 7 and MAX TX RF POWER 868 MHz = 5 it corrispond approximately respectively at 19 dBm and 13 dBm output on the antenna pin (admitted values of regulations in the bands respectively 869.4-869.650 and 868.0-868.6 MHz). It is responsibility of the integrator verify that the antenna + the setting of these two data parameters is comply at the current legislation

The following graph show the power output max as a function of the supply voltage

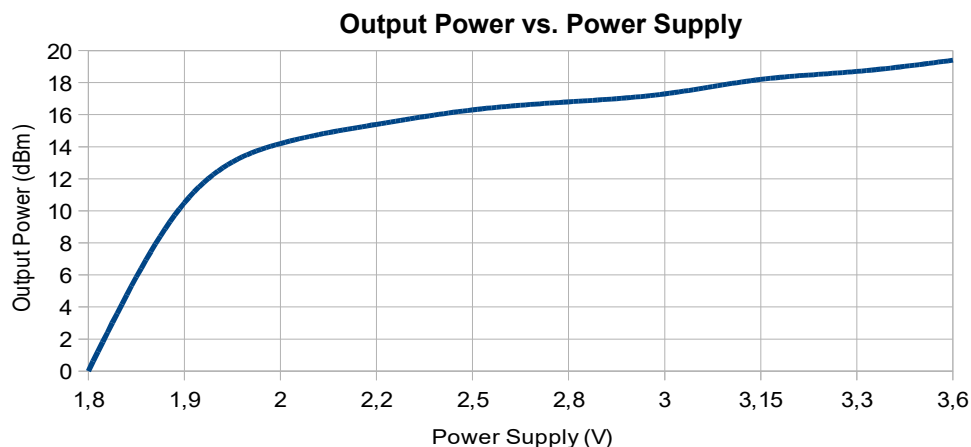



5.3. CH: RF Channel

13 channels placed at a distance of 100 kHz one from another are available for the versions 433 and 868. A particular attention goes to the use of the various available channels, as they are strictly linked to the adopted RF configuration (channel length, baud rate, etc.) in order to respect the approval specifications.

Channel	Central Frequency(MHz)
0	868,105
1	868,235
2	868,365
3	868,495
4	869.525(default)

5.4. RF: RF Configuration

Config	Kbps	RX filter bandwidth	Modulation	Typical Sensitivity (dbm)
0	2	25 KHz	GFSK	-121 (default)
1	20	50 KHz	GFSK	-115
2	40	80 KHz	GFSK	-108

5.5. Addressing

The module allows addressed packet transmissions and broadcast transmissions. Each module has a *Network Address* (one byte) and its own *My Address* (one byte). The Network Address and My Address can be programmed for each module using the configuration interface.

All Node in one system should have the same Network Address, and each node should be set to a different My Address.

5.5.1. NWA: Network Address

The network address helps to filter the RF packets with its own network address; briefly, all radio modems with the same network address are able to communicate among themselves.

5.5.2. MYA: My Address

My address filter all the RF packets that don't have in the destination address field the same value of MA.

MYA = "255" receive all message



5.6. WOR: Wake On Radio Mode (0 or 20 to 64000)

Set the RX mode of the module.

If argument val is '0', module enter RX mode without any power down state.

When argument val is number between 20 to 64000, module goes in power down mode and wake up every val ms.

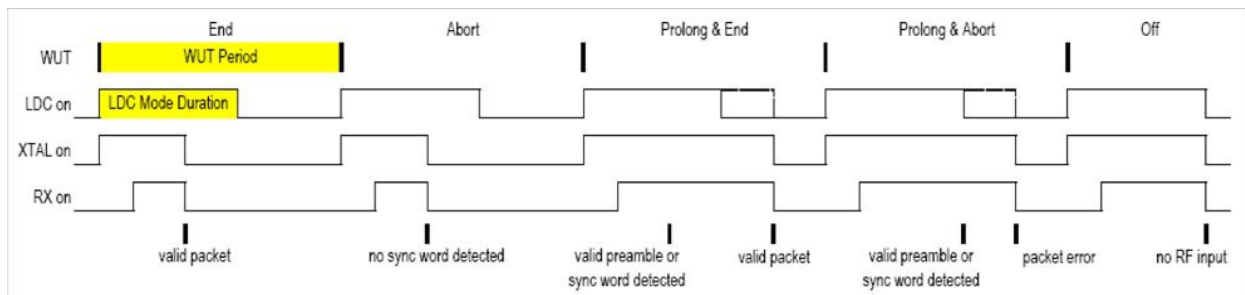

If a valid preamble or sync word is not detected the chip will return to sleep mode until the beginning of a new WUT (Wake Up Timer) period.

If a valid preamble and sync are detected the receiver on period will be extended for the low duty cycle mode duration (LDC) to receive all of the packet.

LDC is fixed in firmware and it is dependet on the RF CONFIGURATION and WUT

Config	Kbps	LDC (mS)	Conditions
0	2	15,87	$20 \leq WUT < 16000$
		16,11	$16000 \leq WUT < 32000$
		16,60	$32000 \leq WUT \leq 64000$
1	20	2,44	$20 \leq WUT < 32000$
		2,93	$32000 \leq WUT \leq 64000$
2	40	1,71	$20 \leq WUT < 32000$
		1,95	$32000 \leq WUT \leq 64000$

Note: The preamble in packet TX must be at least 10% more of the WUT period

When a packet is received, BIT868RM20 set P6(P0.7) to logic HI; then wait for host to set pin P7(P0.6) to logic HI. Then module send to UART the following message:

RX[RSSI_VAL][SRC_ADDR][PLEN][DATA0][DATA1]...[DATAN][CRC] [0x0D][0x0A]

RX are the character 'R' and 'X'

RSSI_VAL is the RSSI of the received message

SRC_ADDR is the address of the sender

DATA0, DATA1, ..., DATAN are the data bytes

RSSI_VAL can take values according to the following figure that also shows the corresponding Input Power.

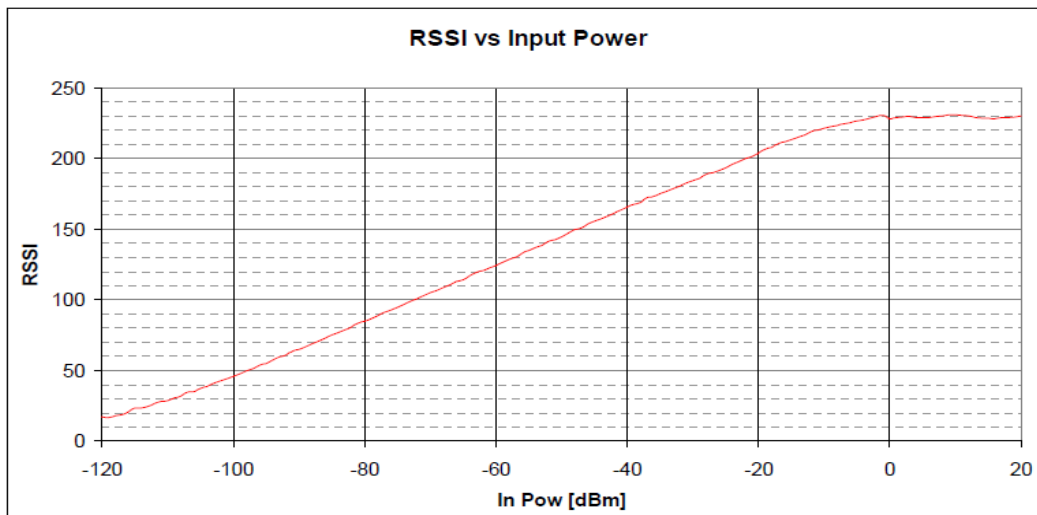

5.7. CCA: Clear Channel Assessment (0 or 20 to 230)

If argument val is '0', CCA mode is disabled;

When argument val is a number between 20 to 230, CCA mode is enabled and the number is the value of RSSI threshold in according to the previous figure that also shows the corresponding Input Power.

When enabled, module does not enter TX mode if current selected channel is busy and module return the string CCA\r\n.

5.8. TX: TX Mode

Set the TX mode of the module. TX command has several parameter.

TX[TIME_PRE_LO][TIME_PRE_HI][DEST_ADDR][PLEN][DATA0][DATA1]...[DATAN]
[CRC] [0x0D][0x0A]

TX are the character 'T' and 'X'

TIME_PRE_LO and TIME_PRE_HI are a 16 bit value (Little Endian) and it is the time of the preamble in ms.

DEST_ADDR is the Destination address (0xFF is broadcast)

PLEN is the packet len number of DATA bytes (max 50)

DATA0, DATA1, ..., DATAN are the data bytes

When transmission is completed, module return the string ETX\r\n.

If transmission is not completed, module return the string ERR\r\n.



5.9. PD: Power Down Mode (0 or 20 to 64000)

Set the Power Down mode of the module.

If argument val is '0', module enter power down mode and exit from power down when uart receive a TX message or WOR setting message

When argument val is number between 20 to 64000, module goes in power down mode and wakes up after val ms or when receive any uart message

In any case, when module exit from power down mode, it switch to last WOR mode.

5.10. STA: Read Module Status

Return an ASCII coded byte (0 to 255). It has to be interpreted in bit mode as below:

bit	7	6	5	4	3	2	1	0
Value	NA	NA	NA	NA	RF PD Active	RF WOR Active	RF TX Active	RF RX Active

5.11. FWVER: Return Firmware Version

Return firmware version as 5 ASCII coded bytes: MM.mm

MM: major version, mm: minor version

Typical Application

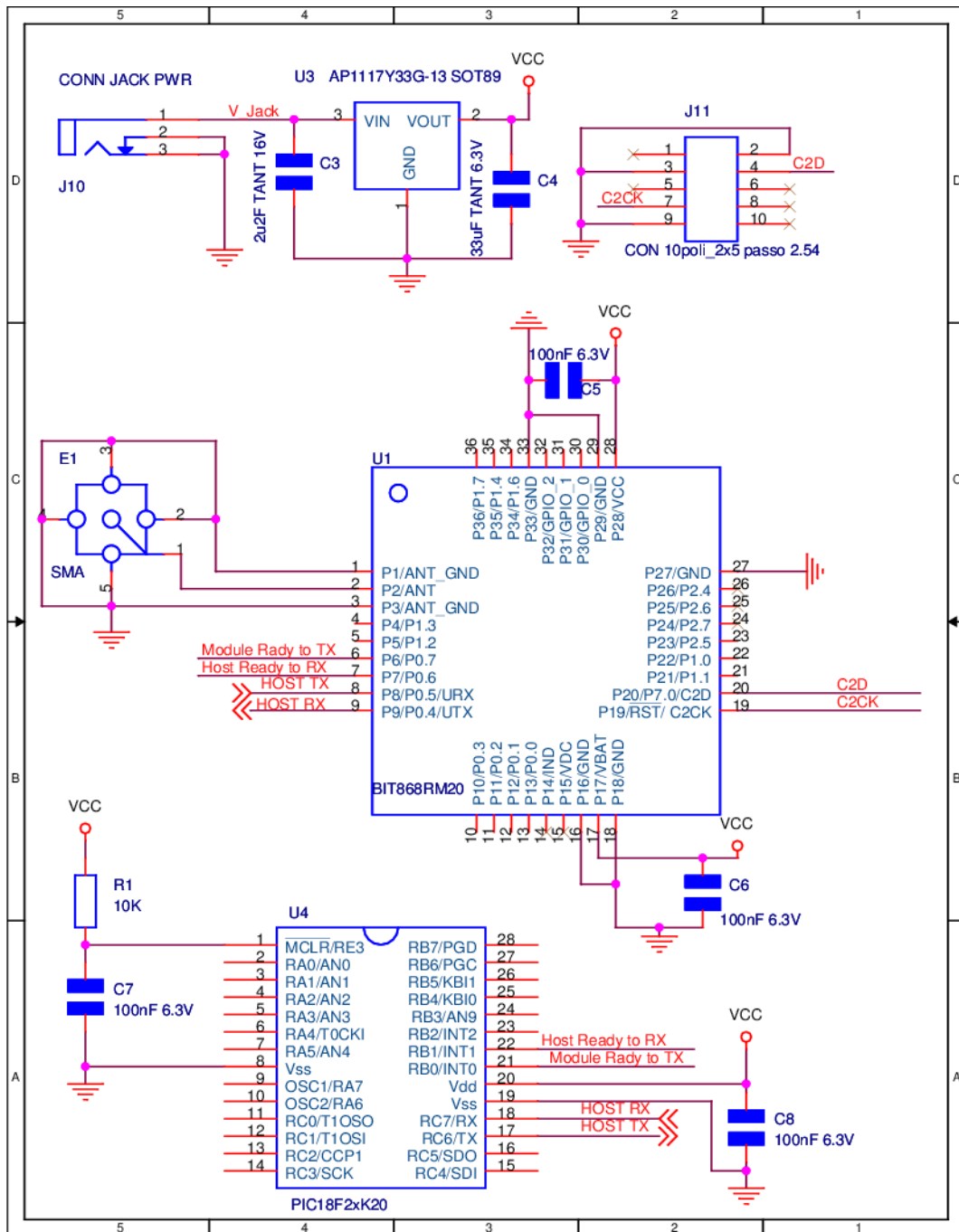



Soldering profile Recommendation

JEDEC standard IPC/JEDEC J-STD-020D.1 (page 7 and 8), Pb-Free Assembly is recommended.

The standard requires that the heat dissipated in the "surroundings" on the PCB is taken into account. The peak temperature should be adjusted so that it is within the window specified in the standard for the actual motherboard.

Aperture for paste stencil is normally areal-reduced by 20-35%, please consult your production facility for best experience aperture reduction. Nominal stencil thickness of 0.1-0.12 mm recommended.

The area underneath the module should be covered with solder resist in order to prevent short circuiting the test pads on the back side of the module. A solid ground plane is preferred.

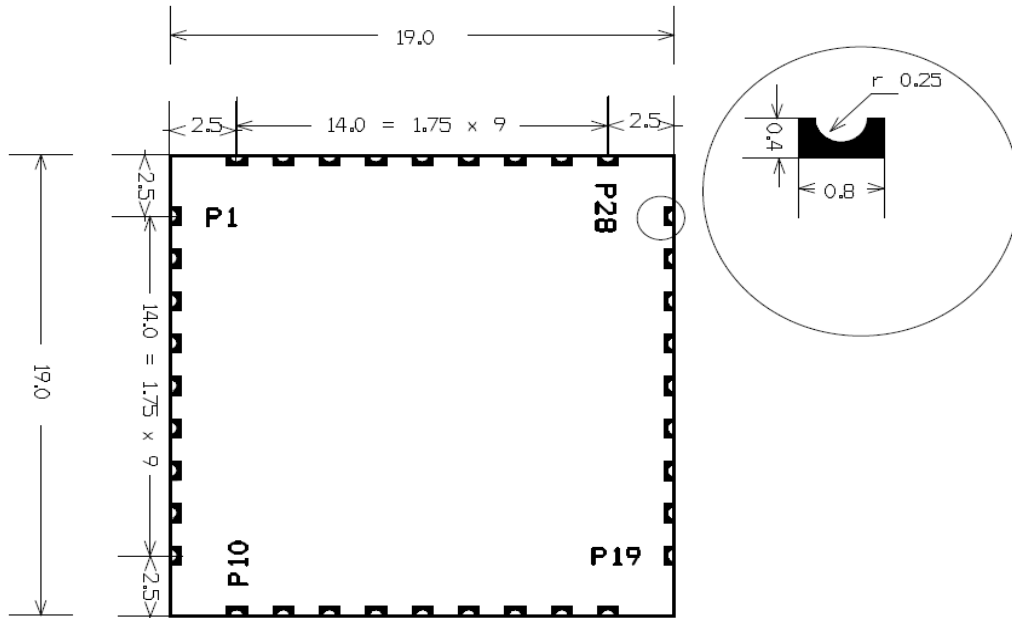
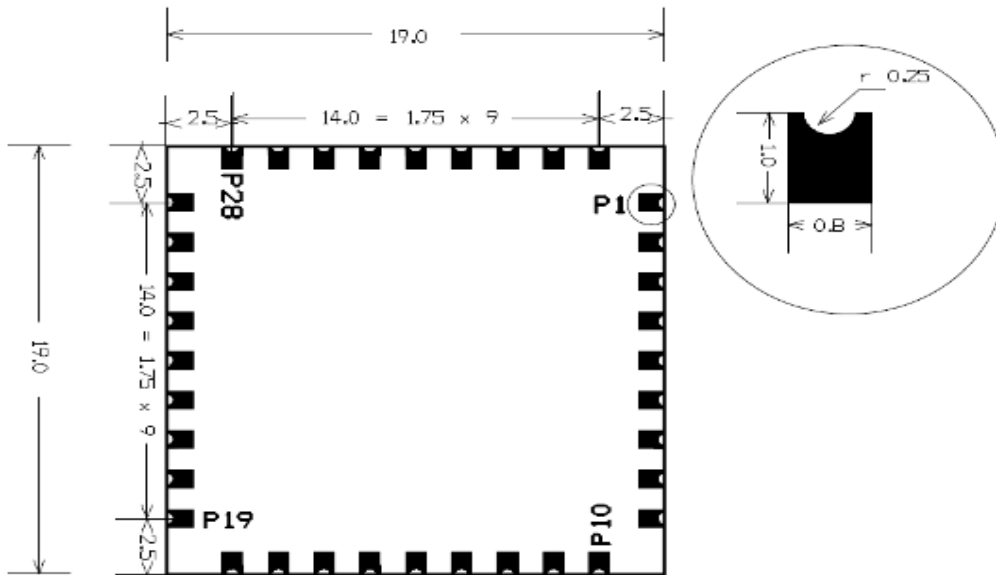
Package Description
Top View

Bottom View



Regulatory Compliance Information ETSI

The use of RF frequencies and maximum allowed RF power is limited by national regulations. The BIT868RM20 has been designed to comply with the R&TTE directive 1999/5/EC.

According to R&TTE directives, it is the responsibility of customers (i.e. BIT868RM20 end user) to check that the host product (i.e. final product) is compliant with R&TTE essential requirements. The use of a CE marked radio module can avoid re-certification of the final product, provided that the end user respects the recommendations established by BIT.

The relevant regulations are subject to change. BIT S.r.l. do not take responsibility for the validity and accuracy of the understanding of the regulations referred above. BIT only guarantee that this product meets the specifications in this document. BIT is exempt from any responsibilities related to regulatory compliance.

If a detachable RF connector is introduced in RF path it must be a non-standard type RP-SMA, U.FI etc. The module have been approved with an external quarter wave antenna with gain = 1.0 dBi. Any use of antenna with gain > 1 dBi is strictly forbidden.

R&TTE Declaration of Conformity

B.I.T. S.r.l. hereby declares that BIT868RM20 modules are in compliance with the essential requirements and other relevant provisions of Directive 1999/5/EC.



Italian	Con la presente B.I.T. S.r.l. dichiara che il modulo BIT868RM20 è conforme ai requisiti essenziali ed alle altre disposizioni pertinenti stabilite dalla Direttiva 1999/5/CE.
English	Hereby, B.I.T. S.r.l., declares that the BIT868RM20 module is in compliance with the essential requirements and other relevant provisions of Directive 1999/5/EC.
Finnish	B.I.T. S.r.l. vakuuttaa täten että BIT868RM20 moduuli tyypinen laite on Direktiivin 1999/5/EY oleellisten vaatimusten ja sitä koskevien Direktiivin muiden ehtojen mukainen.
Deutsch	Hiermit B.I.T. S.r.l. Es erklärt, dass das BIT868RM20 Modul erfüllt die Anforderungen, wesentlichen und anderen relevanten Bestimmungen der Richtlinie 1999/5 / EG.
French	Par la présente B.I.T. S.r.l. déclare que le module BIT868RM20 est conforme aux exigences essentielles et aux autres dispositions pertinentes de la Directive 1999/5/CE.
Swedish	Härmed intygar B.I.T. S.r.l. att denna BIT868RM20 står i överensstämmelse med de väsentliga egenskapskrav och övriga relevanta bestämmelser som framgår av Direktiv 1999/5/EG.
Danish	Undertegnede B.I.T. S.r.l. erklærer herved, at følgende udstyr BIT868RM20 overholder de væsentlige krav og øvrige relevante krav i Direktiv 1999/5/EF.
Greek	Δια του παρόντος B.I.T. S.r.l. Δηλώνει ότι η μονάδα BIT868RM20 συμμορφώνεται με τις απαιτήσεις ουσιαστικό και άλλες σχετικές διατάξεις της Οδηγίας 1999/5 / EK.
Spanish	Por medio de la presente B.I.T. S.r.l. declara que el BIT868RM20 cumple con los requisitos esenciales y cualesquiera otras disposiciones aplicables o exigibles de la Directiva 1999/5/CE.
Portuguese	B.I.T. S.r.l. declara que este BIT868RM20 está conforme com os requisitos essenciais e outras disposições da Directiva 1999/5/CE.



Revision History

Revision	Date	Description
00.01	07/09/2016	First Revision
00.02	03/10/2016	Delete UART Baud Rate 76800
		PLEN change max value from 58 to 50
		Add function on pin P06 and P07 for uart communication
		Add RSSI power on message
00.03	21/10/2016	Fixed problem in conversion ascii data
00.04	25/10/2016	Bug Fixed in read RSSI on RX packet
00.04a	28/10/2016	Add graph "Output Power vs. Power Supply" and "RSSI vs. Input Power" It is only a different revision of data sheet (fw version remain the same)
00.05	09/11/2016	Add WOR and CCA function
00.06	14/11/2016	Add Watchdog Timer
00.07	21/03/2017	More time for Watchdog Timer
00.08	12/06/2017	Fixed problem in TIME_PRE_LO and TIME_PRE_HI



General Information

- **Disclaimer**

B.I.T. srl believes the information contained herein is correct and accurate at the time of this printing. However, B.I.T. srl reserves the right to make changes to this product without notice. B.I.T. srl does not assume any responsibility for the use of the described product; neither does it convey any license under its patent rights, or the rights of others. The latest updates are available at the BIT website or by contacting BIT directly.

As far as possible, major changes of product specifications and functionality, will be stated in product specific Errata Notes published at the BIT website. Customers are encouraged to sign up to the Developers Newsletter for the most recent updates on products and support tools.

Compliance with regulations is dependent on complete system performance. It is the customer's responsibility to ensure that the system complies with regulations.

- **Life Support Policy**

This BIT product is not designed for use in life support appliances, devices, or other systems where malfunction can reasonably be expected to result in significant personal injury to the user, or as a critical component in any life support device or system whose failure to perform can be reasonably expected to cause the failure of the life support device or system, or to affect its safety or effectiveness. B.I.T. srl customers using or selling these products for use in such applications do so at their own risk and agree to fully indemnify B.I.T. srl for any damages resulting from any improper use or sale.

	Bit is Italian Technology S.r.l. Viale delle Industrie, 20 20020 ARESE (MI) Tel.: (+39) 02 30465311, fax: (+39) 02 30465396 http://www.bit.it/ info@bit.it
 A	http://www.kevin.it/ info@kevin.it company